



138cm (4.5ft) Trampoline

S002220

ATTENTION!

SAFETY INFORMATION, INSTALLATION, CARE
AND MAINTENANCE INSTRUCTIONS.

READ PRIOR TO ASSEMBLING AND USING THE TRAMPOLINE

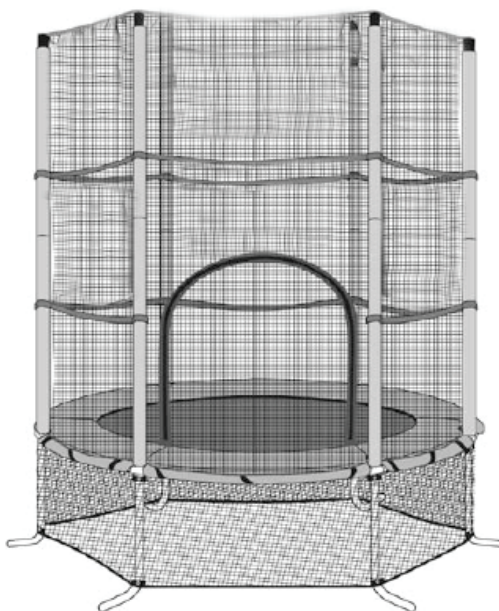

WARNING: To ensure everyone's safety, please do not attempt to assemble this trampoline without reading this instruction manual carefully. Failure to comply with this warning may result in injury and/or property damage.

- Prior to assembly, this trampoline includes small parts/accessories that are not suitable for children under 3 years of age as they may cause a choking hazard.
- This trampoline should be assembled by 2 adults.
- Only use this trampoline on a soft, flat level surface.
- **This trampoline has a maximum user weight of 34kg.**
- This trampoline is suitable for users aged 3 to 6 years of age.
- Do not allow more than 1 person on the trampoline at any time.
- This trampoline is designed for domestic use only, it is not intended for gymnastics or high level acrobatic stunts.

For parts and service enquiries, please contact Action Spares on 1800 465 070 or e-mail service@actionspares.com.au

Contents

- 3** Warnings
- 5** Installation Instructions
- 6** Care and Maintenance Instructions
- 7** Safety Information
- 10** Parts List
- 11** Assembly Instructions
- 16** Warranty Information

Warnings

To reduce the risk of serious injury, read the entire manual before you assemble or use this trampoline. In particular, please note the following safety precautions. Please keep this manual in a safe place for future reference.

1. Prior to assembly, this trampoline includes small parts/accessories that are not suitable for children under 3 years of age as they may cause a choking hazard.
2. It is the responsibility of the owner to ensure that all users of this trampoline are adequately informed of all warnings and precautions. This trampoline is not intended for use by persons (including children) with reduced physical, sensory or mental capabilities; or lack of experience and knowledge unless they have been given supervision or instruction concerning use of the trampoline by a person responsible for their safety.
3. This trampoline should be assembled by 2 adults.
4. Place this trampoline on a soft level surface with at least 2.5m diameter of clear space surrounding the unit. There should also be at least 7m of space above the mat to ensure the user has sufficient space to jump in.
5. **WARNING:** Keep away from fire.
6. This trampoline is suitable for users aged 3 to 6 years of age.
7. **This trampoline has a maximum user weight of 34kg.**
8. Do not allow more than 1 person on the trampoline at any time.
9. This trampoline is designed for domestic use only, it is not intended for gymnastics or high level acrobatic stunts.
10. Do not use the trampoline without the enclosure net.
11. Do not attempt or allow somersaults.
12. Do not use the trampoline when wet.
13. Do not jump into or off of the enclosure net.
14. Do not use the trampoline while under the influence of alcohol or drugs. Balance, perception and assessment of risk will be affected and may lead to injury.
15. Do not allow any activity underneath the trampoline.
16. Users should be barefooted or only wearing socks when using the trampoline, footwear must not be worn.
17. Do not use foreign objects with the trampoline, use of any foreign objects will void the warranty.

Warnings (cont)

18. Inspect the trampoline before each use, replace any worn or defective parts. If you require replacement parts to be sent out, please contact our National Service Centre (details can be found in the warranty pages at the end of this manual).
19. Ensure that the frame padding is correctly and securely positioned prior to use.
20. Climb on and off the trampoline, do not jump on or off. It is dangerous to jump from the trampoline to the ground when dismounting, or onto the trampoline when mounting. Always use two hands to hold onto the frame when getting on or off the trampoline. Never use the springs or enclosure poles as hand grips. Small children may need assistance getting on or off of the trampoline.
21. When bouncing on the trampoline, always aim for the centre of the mat. Focus your eyes on the edge of the trampoline. This will help you control your bounce. Bouncing near the edge of the mat can lead to injury and stretch the springs. The frame pad is not designed to support the weight of the trampoline user.
22. Stop your bounce by flexing your knees as your feet come in contact with the mat. Learn this skill before you attempt any other.
23. Avoid bouncing too high. Stay low until you can control your bounce and repeatedly land in the centre of the mat.
24. Do not use the trampoline as a springboard to other objects. Use the trampoline only for trampoline style bouncing.
25. Do not bounce on the trampoline immediately after a meal.
26. Jewellery should be removed before using the trampoline as this may cause an injury to the user and/or damage the trampoline.
27. Users should only use the trampoline under adult supervision.

Installation Instructions

Place the trampoline on a flat level surface with impact attenuating properties such as grass and ensure that it is sufficiently stable to prevent it from tipping over and/or blowing away. Sandbags or pegs may be suitable anchorage devices.

Keep a minimum of 5m overhead clearance when measured from the bed height to prevent users inadvertently contacting overhead hazards such as electric wires, tree limbs and clotheslines.

Maintain a minimum clearance of 1.5 m on all sides of the trampoline. This area should not include concrete, bitumen, brick or other hard surfaces as these can cause serious injuries if users fall off the trampoline.

Do not locate the trampoline on top of other objects or store anything underneath the trampoline bed.

NOTE: Children have been injured while bouncing on trampolines and landing on for example garden tools, bicycles, etc.

Keep the area surrounding the trampoline clear. Place the trampoline away from walls, structures, fences and other play areas.

Place the trampoline in a well-lit area.

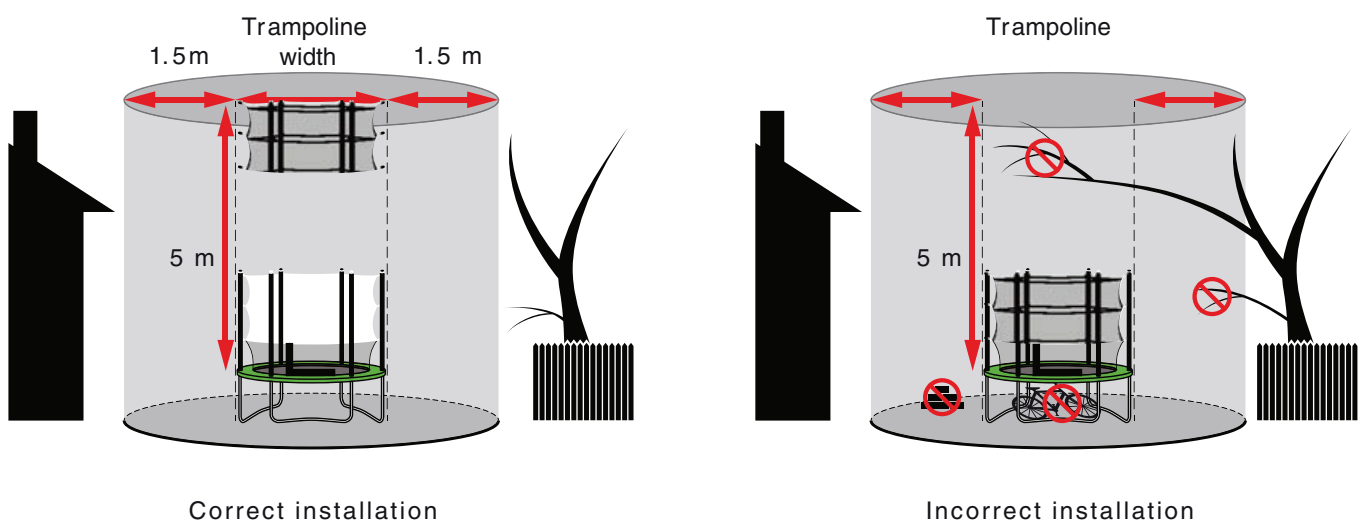

Care and Maintenance Instructions

Components of this trampoline are susceptible to deterioration from use and environmental conditions, such as sunlight, rain, salt and heat, to varying degrees. It is essential that you inspect the trampoline before each use and replace any worn, defective, or missing parts before further use. Use only parts that are recommended by the manufacturer.

POTENTIAL HAZARDS OF TRAMPOLINE COMPONENTS

Trampoline frame	Trampoline bed	Frame-padding	Enclosure system
<p>Bending or breakage of the frame</p> <p>Broken, stretched or missing springs</p> <p>Sharp protrusions on the frame</p>	<p>Punctures, frays, tears or holes in the bed or edge system</p> <p>Deterioration in the stitching or fabric of the bed or edge system</p> <p>Sagging of the bed</p> <p>Sharp protrusions in the suspension system elements</p>	<p>(where required)</p> <p>Missing, improperly positioned or insecurely attached frame-padding</p> <p>Punctures, frays, tears, or holes in the frame-padding</p> <p>Deterioration of the stitching or fabric of the frame-padding and/or its securing system</p> <p>Damaged or degraded padding</p>	<p>Missing, improperly positioned, or insecurely attached:</p> <p>(a) Barrier.</p> <p>(b) Barrier supports.</p> <p>(c) Pole caps.</p> <p>Punctures, frays, tears, or holes in the barrier</p> <p>Damage to the support pole padding (when padding is required)</p> <p>Deterioration in the stitching or fabric of the barrier</p> <p>Sagging of the barrier</p> <p>Bent or broken barrier supports</p> <p>Sharp protrusions on the barrier support structure</p> <p>Broken or damaged enclosure entry system</p>

Safety Information

Trampolines are great fun, encourage the development of gross motor skills; provide opportunities for physical activity and present users with manageable challenges to find and test their limits. However, like many physical activities, trampoline use involves potential risk of injury, particularly if the equipment is used improperly.

Injury surveillance and hospital admissions data shows that trampolines feature frequently in injury presentations and admissions. Children under 14 years of age account for about 90% of all trampoline-related injuries. 28% of the trampoline-related injuries were sustained by children under five years of age and more than a third of the injuries related to multi-users. (Victorian Injury Surveillance Unit—Hazard 75, Autumn 2013, pg. 3.)

The following points are important to note:

- Injury data indicates that people can be severely injured if they land on an unprotected trampoline frame or springs or if they fall from the trampoline. Impact attenuation systems such as pads are intended to minimize the risk of injury and enclosures are intended to stop people falling off the trampoline.
- Ensure pads (where they are required) and enclosures are attached to the trampoline before use.
- The risk of injury increases when more than one person at a time bounces on a trampoline. Smaller children are at increased risk when jumping with adults and/or larger children, for example, a 'double bounce' dramatically increases the energy transferred to the smaller body and children's legs have been broken and severe spinal injuries have occurred as a result.
- Ensure only one person at a time bounces on the trampoline.
- Children are often unable to identify hazards and do not have a well-developed ability to assess risk and may, if left unsupervised, be at more risk of injury.
- Always supervise children while they are using the trampoline.
- Over-confidence can lead to injury.
- Learn fundamental bounces first before trying more complex manoeuvres.
- Inappropriate clothing can cause injury.
- Clothing should allow plenty of body movement without flapping loosely and becoming a distraction to the jumper.

Safety Information (cont)

- Wear clothing free of drawstrings, hooks, loops or anything that could get caught while using the trampoline and result in entanglement or strangulation. Buckles, jewellery and belts should not be worn, as these may damage the trampoline mat or cause injury to the jumper if they become caught in the fabric of the trampoline. Shoes should be removed as they may damage the bed and increase the risk of injury.
- Better design, good construction and improved safety features go a long way toward minimizing the hazards associated with trampoline use; however, trampolines need to be used, cared for and maintained appropriately to ensure the benefits of these features continue throughout the life of the product.

Safe Use Instructions

To reduce the risk of injury while using the trampoline, develop household rules such as the following:

- Do not allow children under 3 years on the trampoline.
- Allow only one person on the trampoline at any one time.
- Active, competent supervision is essential—always supervise children while they are using the trampoline.
- Ensure any pads (where they are required) covering the frame/suspension system are securely attached at all times.
- Ensure the enclosure is securely attached and in good condition at all times.
- Check the trampoline before use and ensure it is in good condition. Replace any worn or broken parts. Use only parts that are recommended by the manufacturer.
- Make sure that the area around, underneath and above the trampoline is clear of objects that could interfere with the person jumping. Do not allow children, pets, toys or other play equipment to be present under the trampoline.
- Adults should model safe use of trampolines when children are present.
- Wear comfortable clothing that won't become entangled in the trampoline's components and become a strangulation hazard. Do not wear jewellery or drawstrings/cords that can catch on the trampoline and create a strangulation hazard. Remove shoes as they may damage the bed and increase the risk of injury.
- Children should be educated by responsible adults to always climb on and off the trampoline, and never jump or bounce off. It is dangerous practice to jump or bounce from the trampoline when dismounting. Never use springs or suspension elements as 'hand grips' when getting on and off the trampoline.

Safety Information (cont)

- Learn fundamental bounces and body positions thoroughly before trying more advanced manoeuvres. A variety of trampoline activities can be carried out by performing the basic fundamentals in various series and combinations, or performing one fundamental bounce after the other, with or without bounces between them.
- For further information or additional instructional material, contact the manufacturer or retailer. To learn more advanced trampolining skills contact a suitable gymnastics/trampoline club.

Basic Trampolining Instructions

This trampoline is a domestic trampoline, not a gymnastics trampoline. You will get the safest and best use from it by following these basic principles:

- Do not attempt or allow somersaults on the trampoline. Landing on your head or neck while doing somersaults can cause serious injury, paralysis or even death.
- Do not use the trampoline when wet. The mat will be slippery and make landing less sure.
- Enclosure systems are designed to prevent users falling off the trampoline. Do not allow users to intentionally bounce toward or off the barrier, as this can unbalance the trampoline and continual impact may damage the enclosure.
- Do not use the trampoline as a springboard to other objects. Use the trampoline only for trampoline style bouncing.
- Focus your eyes on the edge of the trampoline. This will help control your bounce.
- Stop your bounce by flexing your knees as your feet come in contact with the trampoline bed. Learn this skill before you attempt any others.
- Avoid bouncing too high. Stay low until you can control your bounce and repeatedly land in the centre of the trampoline.
- Do not bounce immediately after a meal.

Parts List

Part No.	Description	Qty
A	Top Rail	6
B	T-Joint	6
C	Leg Tube	6
D	Mat	1
E	Frame Pad	1
F	Net	1
G	Skirting	1
H	Upper Enclosure Pole	6
I	Lower Enclosure Pole	6
J	Elastic Toggle Loop	32
K	Screw (Ø4*16mm)	30
L	Screwdriver	1

NOTE: Some parts may be supplied pre-assembled.

Assembly Instructions

Step 1

Lay out the parts on a clear dry level surface as shown in Figure 1. The T-Joints (B) should be placed between each Top Rail. Connect the Top Rail (A) by sliding it into the T-Joints (B) to form the top rail loop as shown in Figure 2.1.

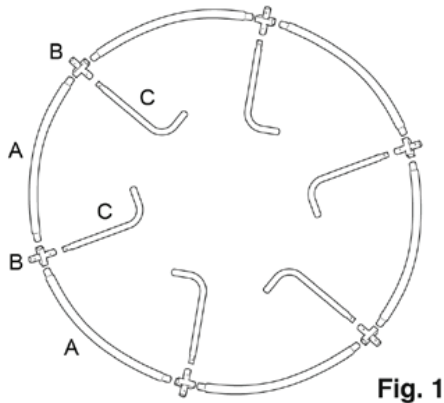

Fig. 1

ATTENTION: Make sure the two ends with a groove on the Top Rail Tube (A) are facing down to the ground. See Fig. 2.2

To complete assembly of the Legs. Join the Leg Tube (C) to the Top Rail and leave the hole without screw at this stage. The screw will be used in later step when the skirting is connected as well.

Once completed, the frame of the Trampoline should look like Figure 4.

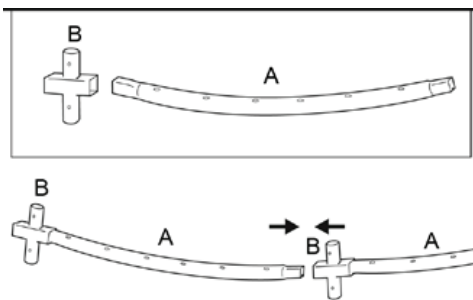

Fig. 2.1

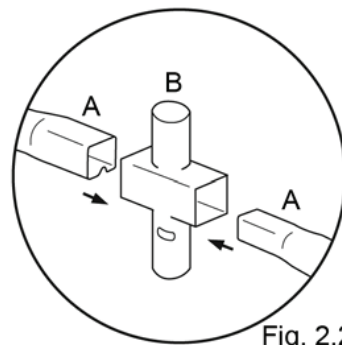

Fig. 2.2

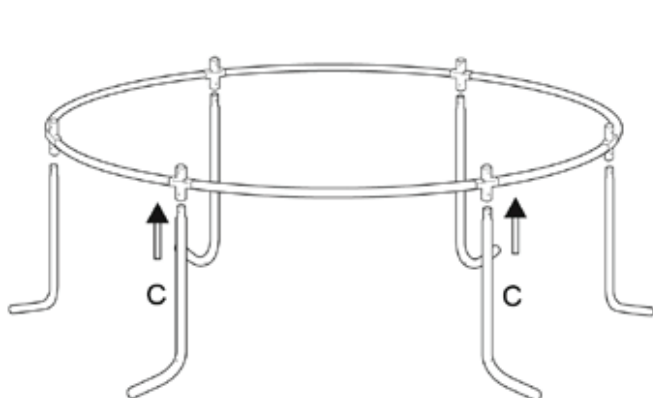

Fig. 3

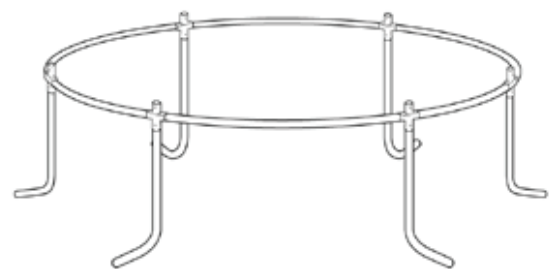

Fig. 4

Assembly Instructions (cont)

Step 2

WARNING: Avoid eye injury DO NOT over stretch. ALWAYS keep face and body out of recoil path. DO NOT use when the Elastic Toggles have visible signs of wear or damage.

Spread out the Mat (D) and the Elastic Toggle (J) ready for assembly as shown in Figure 5. Thread the Elastic Toggle (J) through the Mat (D) one by one, when it is finished, it should look like Figures 6 & 7.

Fig. 5

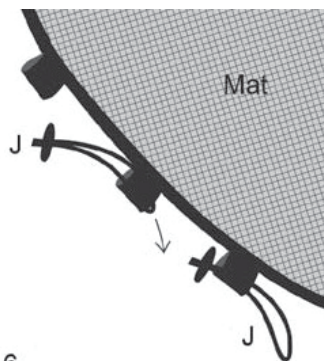
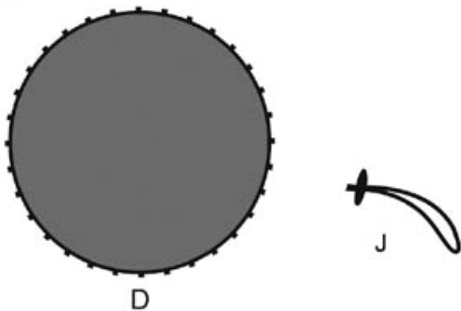

Fig. 6

Fig. 7

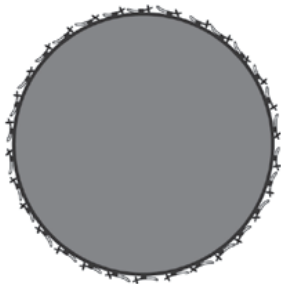
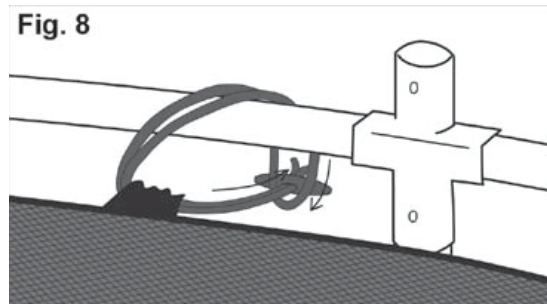

Fig. 8



Secure the Elastic Toggle (H) to the Top Rails as shown in Figures 8 – 12

Fig. 9

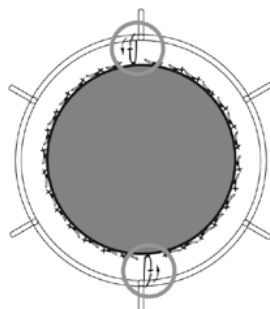

Fig. 10

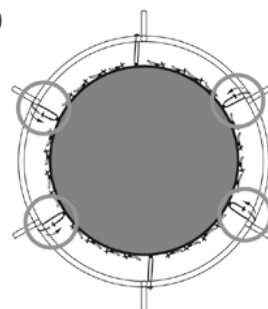

Fig. 11

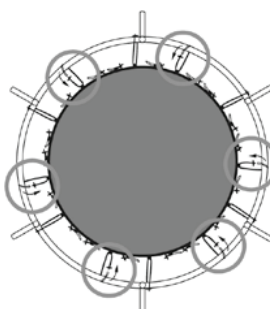
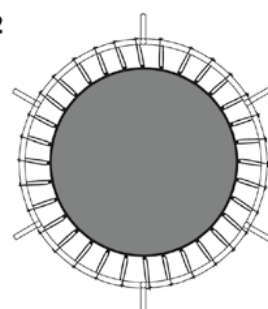

Fig. 12



Assembly Instructions (cont)

Step 3

When the Elastic Toggles have been properly connected, the trampoline should look like Figure 13.

Frame Pad and Skirting Assembly Place the Frame Pad (E) on the top of the trampoline as shown in Figure 14. Straighten and adjust the hangover of the pad. Bring the bungee strap with clip around the outside of the frame and under the pad. Pull the bungee strap and clip to the pre-sewn loop. See Figures 15 & 16.

Attach the skirting (G) to the bottom of the trampoline and secure with Screw (K). See Figures 17 & 18.

Fig. 13

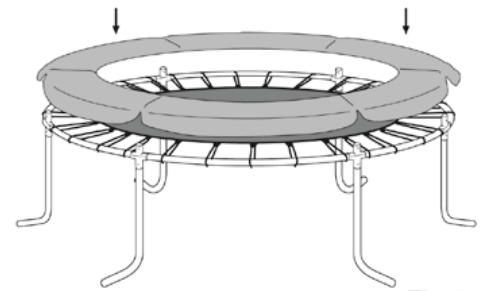
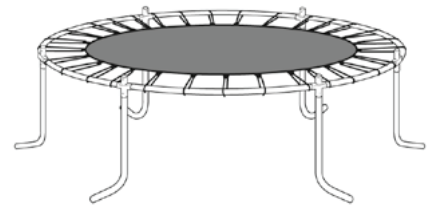

Fig.14

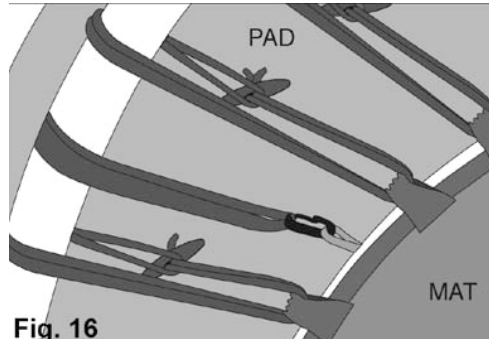
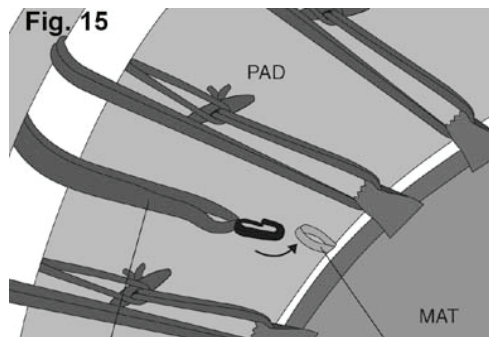

Fig. 16

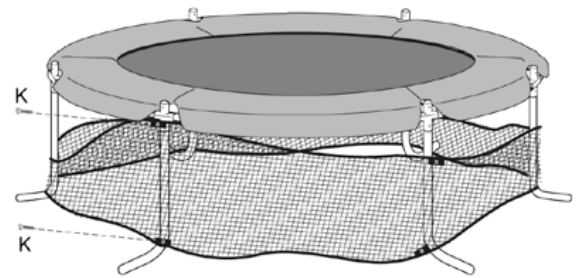

Fig.17

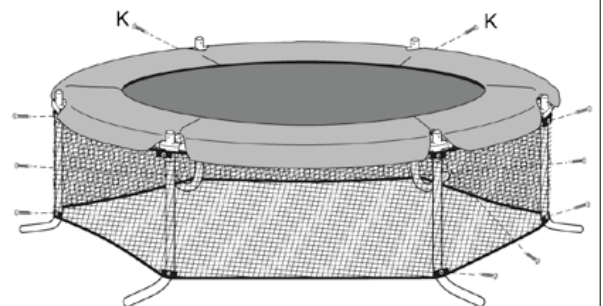
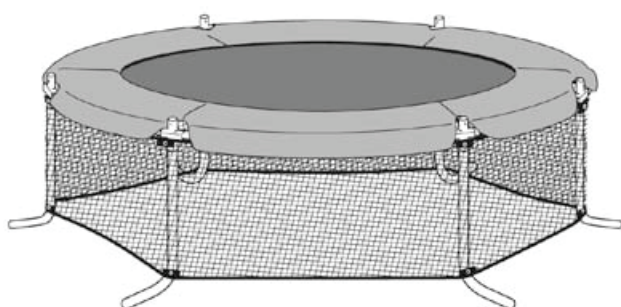

Fig.18

When the screws have been properly screwed in the trampoline should look like Figure 19.

Fig. 19



Assembly Instructions (cont)

Step 4

Attach the Upper Enclosure Poles (H) and the Lower Enclosure Poles (I) which have both been pre-assembled with foam; and secure with Screw (K). See Figure 20 .

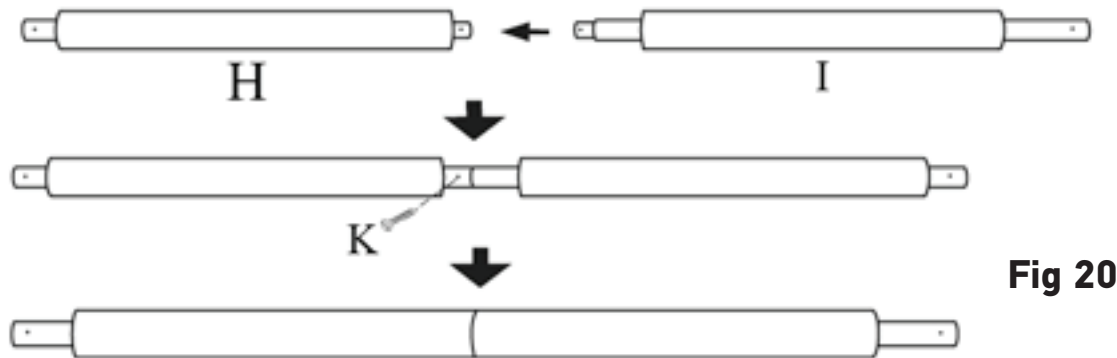

Fig 20

Insert each assembled Enclosure Pole to every T-Joint (B) of the trampoline in an upright position; and fasten with Screw (K). See Figures 21 & 22.

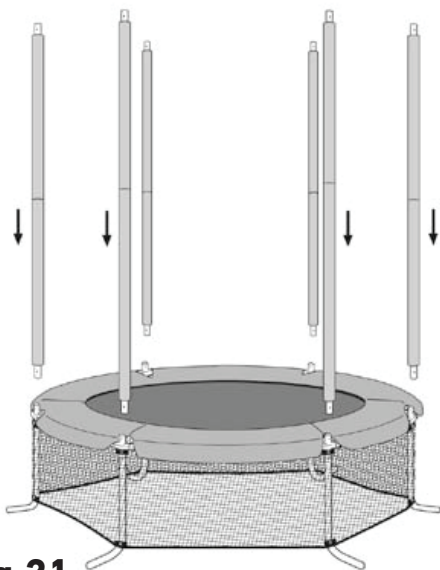

Fig 21

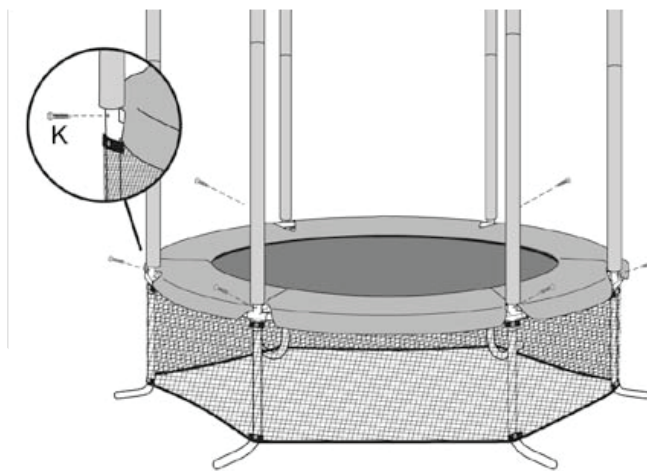

Fig 22

Raise the net and attach the Net to the top of each Enclosure Pole, align the hole and fasten with the Screw (K). See Figures 23 & 24.

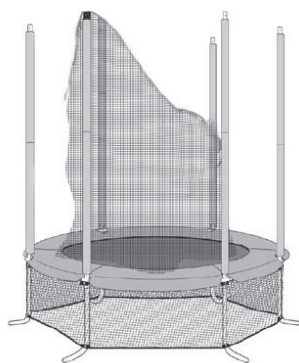

Fig 23

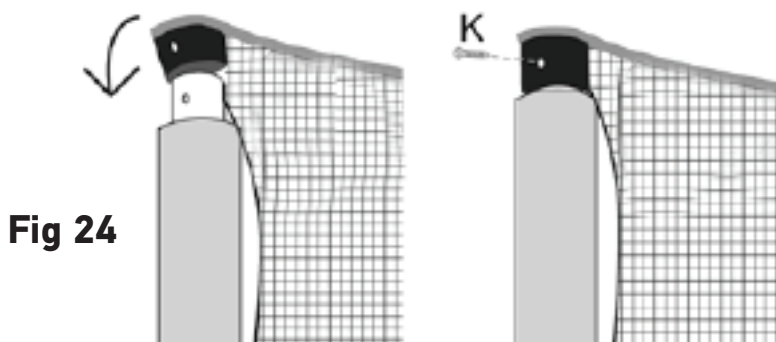

Fig 24

Assembly Instructions (cont)

Step 5

There is a row of sewn-in hook and loop tapes, two hook and loop tapes in line. Attach these hook and loop tapes securely to each of the poles. Adjust the net to make sure the hook and loop tapes are securely fastened.

The panel with a zipper doorway should be located in the place where it is easiest to get in and out of the trampoline. See Figures 25 & 26.

Inspect the whole trampoline to make sure all the loops, hooks and loop tapes and elastic straps are securely attached. Check that the enclosure is positioned evenly around the trampoline and that it is not under strain on any particular one point.

IMPORTANT: When assembled, the padding should lie flat on the trampoline bed with the net tucked underneath.

There is a plastic warning placard enclosed with the enclosure package. Permanently affix this warning placard to an enclosure pole next to the entrance of the trampoline so that it is clearly visible.

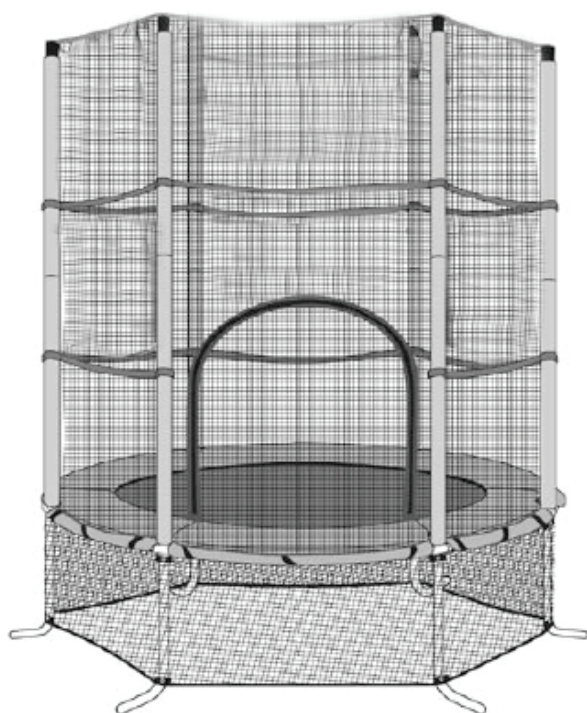

Fig 25

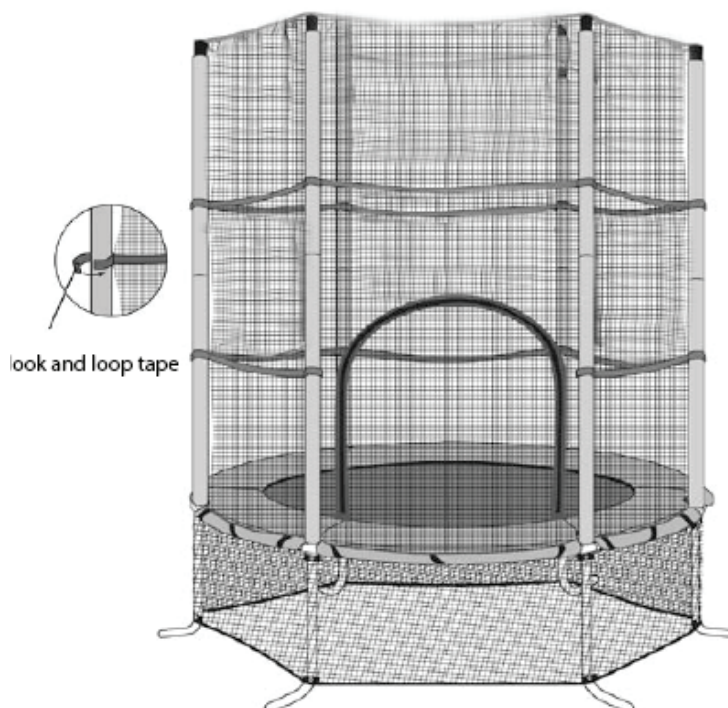

Fig 26

Warranty Information

Congratulations on your purchase!

This **138cm (4.5ft) Trampoline** is warranted to be free from defects in material and workmanship under normal use and service conditions for a period of **2 years** on the frame and mat, **12 months** on all other parts, from the date of purchase of this article. Evidence of unfair usage or incorrect adjustment by the owner will void this promise.

Our goods come with guarantees that cannot be excluded under the Australian Consumer Law. You are entitled to a replacement or refund for a major failure and for compensation for any other reasonably foreseeable loss or damage. You are also entitled to have the goods repaired or replaced if the goods fail to be of acceptable quality and the failure does not amount to a major failure.

The benefits conferred by this warranty are in addition to the consumer guarantees and other rights and remedies in respect of the product which the consumer has under the Australian Consumer law.

Conditions of Warranty

All warranty coverage extends only to the original retail purchaser from the date of purchase. Please keep your receipt, tax invoice or other proof of purchase.

This warranty does not extend to any damage to a product caused by abuse, improper or abnormal usage, or repairs not provided by us or our Service Centre. Nor does this warranty extend to products used for commercial or rental purposes. This warranty does not cover ordinary wear, tear and weathering, failure to follow directions, improper installation, improper maintenance or acts of God (such as damage caused by storms, lightning, heavy winds and by snow or ice).

Making A Warranty Claim

In order to make a claim under this warranty please direct your enquiries to our Service Centre. You can contact them on our

Freecall 1800 465 070 number or send mail to them at National Service Centre: 2/24 Anderson Road, Smeaton Grange, NSW 2567 – if mailing please include your contact details.

A service representative will then assist you in the appropriate action to be taken. For efficient processing of your enquiry please have proof of purchase, the date of purchase and the retailer name you purchased the item from, and the brand on the product. Photos of the product, and scans of receipts, may be requested to assist with your claim.

Warranty Information (cont)

The service centre representative will assess the claim. If:

- 1) **There is a minor fault**, they can offer either a replacement spare part, replacement unit, repair or other suitable remedy.
- 2) **There is a major fault**, they can offer a replacement, repair or suggest you return to the store you purchased it from for a full refund.

PLEASE NOTE: a request for compensation will need documentary evidence of the loss or damage suffered. It will also need to be evidenced that such a loss was a reasonably foreseeable result of a failure to comply with a consumer guarantee under the Australian Consumer Law.

- 3) **The product was damaged through abnormal use**, no refund or repair can be offered.

The sending of replacements, spare parts or the cost of repair carried out will be organized and covered by the Service Centre. If collection of the item is required this will be organized by the Service Centre and at our expense. Do not return any products without authorization as this will be at your expense.

Our sales and service centre has been set up to provide assembly assistance, replacement parts and accessories, and to efficiently handle all warranty related matters. Please note upon receiving your warranty claim our Service Centre will send, via post or email, a repair and refurbished goods or parts notice.

SERVICE CENTRE

Contact details and hours of operation.

Freecall 1800 465 070

9:00am – 4:30pm Monday to Friday (excluding Public Holidays)

9:00am – 3:00pm Saturday

This product is warranted and distributed by:

Action Sports of 48B Egerton St, Silverwater NSW, 2128

Phone: (02) 8799 3500

© 2018 Action Sports Equipment Pty Ltd.

To confirm your warranty period, register your product at
www.actionsports.com.au/register-your-product/