

7 Station Swing Set

S002004

Instruction Manual

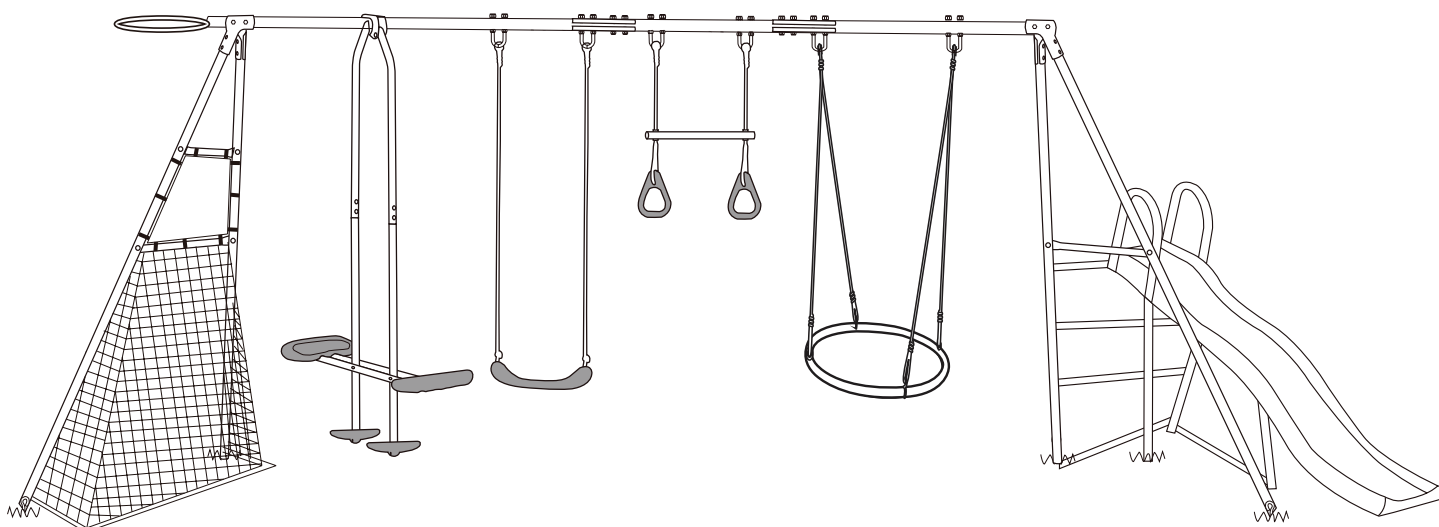

WARNING: To ensure your safety, please do not attempt to assemble this swing set without reading this instruction manual carefully. Failure to comply with this warning may result in injury and/or property damage.

- Prior to assembly, this swing set includes small parts/accessories that are not suitable for children under 3 years of age as they may cause a choking hazard.
- This swing set should be assembled by 2 adults.
- Only use this swing set on a soft, flat level surface.
- **This swing set has a maximum user weight of 34kg per unit/seat. Only one child per seat at any time.**
- The total weight on the swing set at any time must not exceed 204kg.
- This swing set is suitable for users aged 3-9 years.
- This swing set is designed for outdoor domestic use only, it is not intended for commercial use in play centres, nurseries etc.

For parts and service enquiries, please contact Action Spares on 1800 465 070 or e-mail service@actionspares.com.au

Contents

- 3 Important Safety Information**
- 5 Swing Parts List**
- 6 Slide Parts List**
- 7 Assembly Instructions**
- 17 Warranty**

Important Safety Information













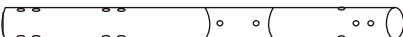
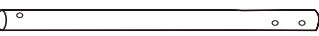





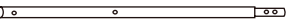

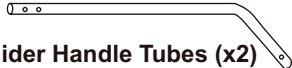





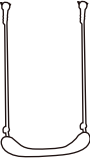

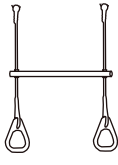

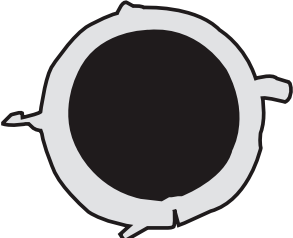

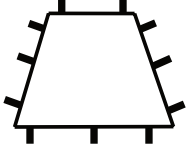

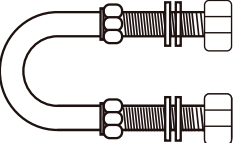



To reduce the risk of serious injury, read the entire manual before you assemble or use this swing set. In particular, please note the following safety precautions. Please keep this manual in a safe place for future reference. Failure to assemble and maintain this product correctly may cause injury to the user.

1. Regularly check the swing set for wear and damage, replace any worn or damaged parts immediately. Remove the swing set from use until replacement parts are fitted. Check all hardware regularly and tighten when required.
2. Check swing seats, ropes and any other means of attachment for evidence of deterioration prior to each use.
3. Prior to assembly, this swing set includes small parts/accessories that are not suitable for children under 3 years of age as they may cause a choking hazard.
4. Do not overtighten the nuts and bolts. Use hand tools only, do not use power tools as this can weaken the connection points.
5. This swing set should be assembled by 2 adults.
6. This swing set is designed for use by children 3-9 years of age.
7. This swing set is designed for domestic use only, it is not intended for commercial use in play centres, nurseries, etc.
8. This swing set has a maximum user weight of 34kg per unit, totalling 204kg across the entirety of the swing set.
9. Do not install this product over concrete, asphalt or any other hard surface.
10. Do not orientate the swing set directly towards the sun.
11. There should be at least 2m of space surrounding the swing set from any structure of obstruction such as a fence, garage, house, wall, overhanging branches, laundry lines, electrical wires, etc.
12. Swings must not exceed an angle of 60 degrees from the ground.

Warnings (cont)

13. The knots in the swings are integral to the safety of the swing set. Please ensure they are tight and that the swing is in the correct position, there should be no slack in the rope allowing a loop to form below the swing.
14. The minimum distance between any swing and the ground is 350mm.
15. This swing set must be anchored firmly into the ground using the included anchor pegs.
16. Do not allow additional foreign objects to be attached or used with the swing set.
17. Children must be supervised by an adult at all times when the swing set is in use.
18. Only 1 child should use each swing (unless specifically designed for 2 children) or slide at any time.
19. Do not use the swing set when it is wet as it will become slippery and serious injury may result.
20. Do not stand on the seats when using the swing set.
21. Do not climb on or jump from the swing set when it is in motion.
22. Do not climb or hang on the frame of the swing set.
23. Do not walk close to, in front of or behind the swing set when in use as moving units can cause serious injury.
24. Do not wear apparel such as hats with straps, helmets, scarves, garments with pull strings or any other item of loose clothing while using the swing set as children can get trapped and may be unable to free themselves causing serious injury.
25. Do not twist swing ropes or wrap them over the top bar.
26. Do not slide head first down the slide, walk up the slide or jump/climb off the slide.

Swing Parts List

- | | | |
|---|--|--|
| 1  Top Bar A (x1) | 52  Connection Tube (x2) | 2  Top Bar B (x1) |
| 3  Top Leg (x2) | 7  Glider Bracket (x1) | 4  Top Bar C (x1) |
| 6  Side Stay Bar (x2) | 14  Spanner (x1) | 5  Plain Bottom Leg A (x1) |
| 9  Glider Leg (x2) | 40  Netball Ring (x1) | 8  Glider Handle Tubes (x2) |
| 12  Glider Seat (x2) | 47  Allen Key (x1) | 10  Glider Seat Tubes (x2) |
| 13  Glider Footrest (x2) | 17  Soccer Goal Net (x1) | 15  Side Stay Bar (x1) |
| 16  Swing Seat (x1) | 39  Top Leg (x2) | 18  Plain Bottom Leg B (x1) |
| 46  Trapeze (x1) | 43  Nest Swing Rope (x2) | 37  Soccer Goal Bottom Tube A (x1) |
| 11  Nest Swing Fabric (x1) | 41  Nest Swing Metal Frame With Foam Padding (x4) | 38  Soccer Goal Bottom Tube B (x1) |
| 45  Fabric (x1) | G15  M8 BOLT 67mm (x4) | 42  Plain Bottom Leg C (x2) |
| S1  M8 U BOLT (x6) | F2  M6 BOLT 52mm(x14) | 50  Clamps (x2) |
| G4  M8 Bolt 82mm (x2) | G3  M6 Bolt 66mm (x2) | 51  Short Bracket (x4) |
| G10  M6 Bolt 32mm (x4) | G1  M6 Bolt 47mm (x2) | 53  Long Bracket (x2) |
| G7  M6 BOLT 62mm (x2) | G6  M6 Bolt 38mm (x8) | G2  M8 Bolt 39mm (x2) |
| | G8  Thin Plastic Spacer (x4) | G5  M6 Bolt 40mm (x2) |
| | | G9  Thick Plastic Spacer (x4) |

Slide Parts List

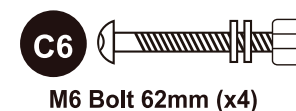
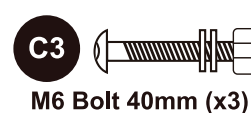
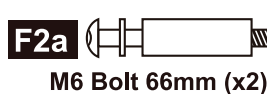
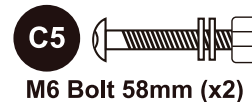
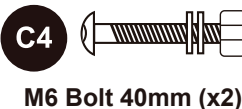
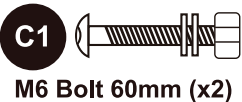
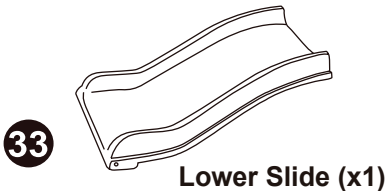
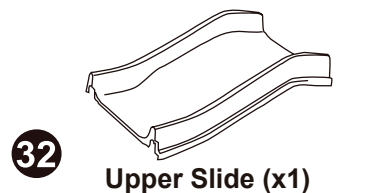
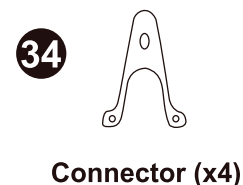
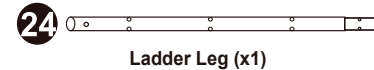
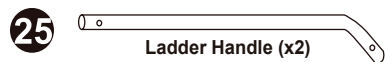
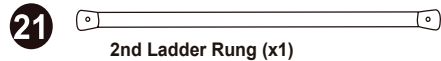
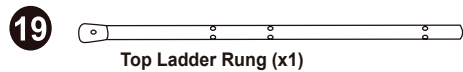

Ruler - Use this ruler to help correctly identify the hardware



Assembly Instructions

Step 1

Frame, Swing, Trapeze & Netball Ring Assembly

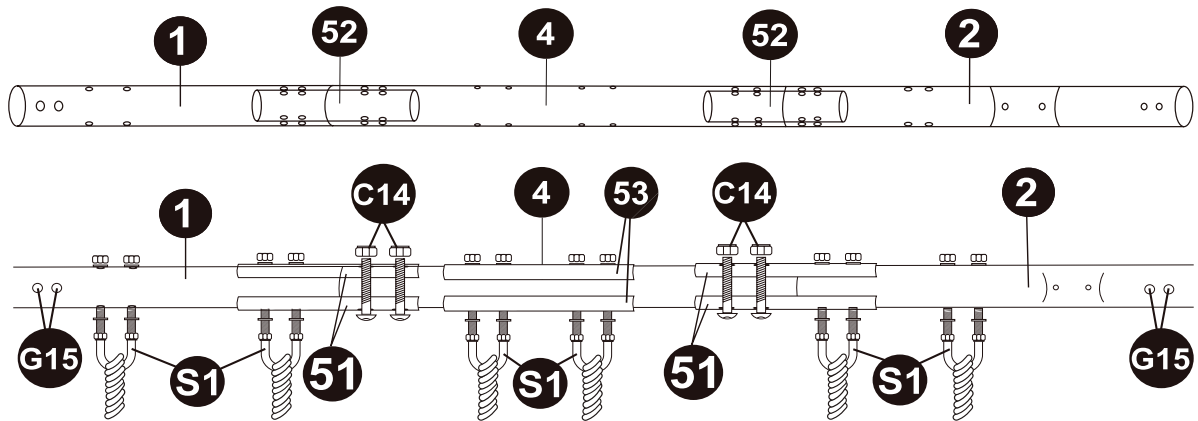
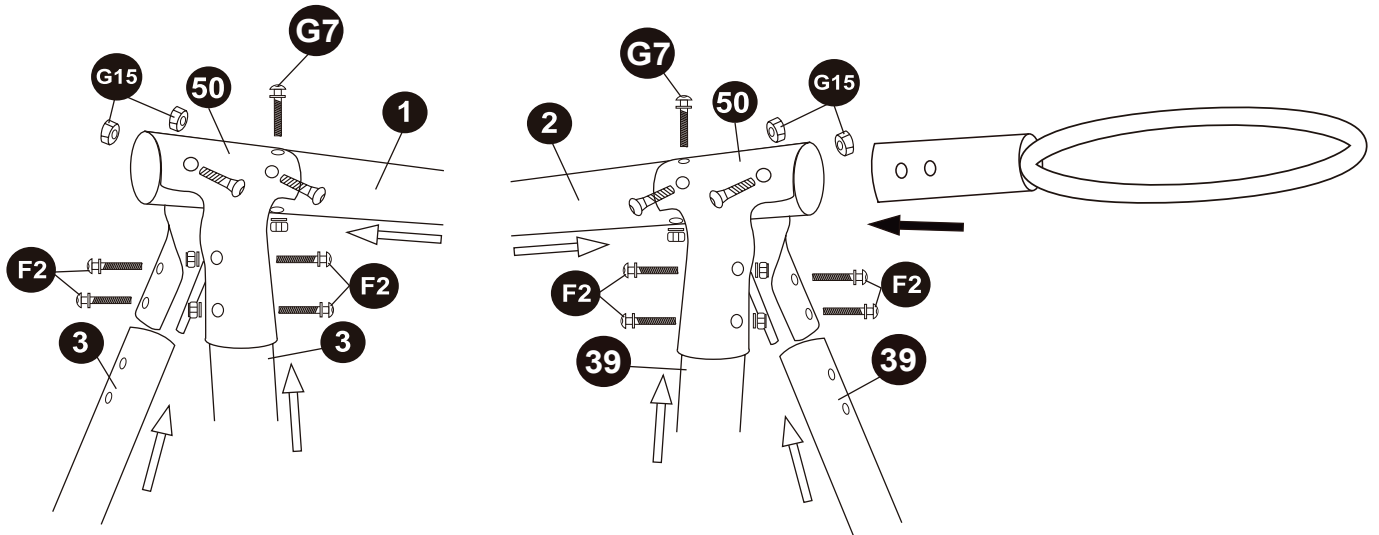

Note: Attach the swing rope to the U-bolt (S1) before connecting the U-bolt (S1) to the top bar. Ensure that at least 3 threads from M8 U-bolt (S1) protrude from the top.

Assembly Instructions (cont)

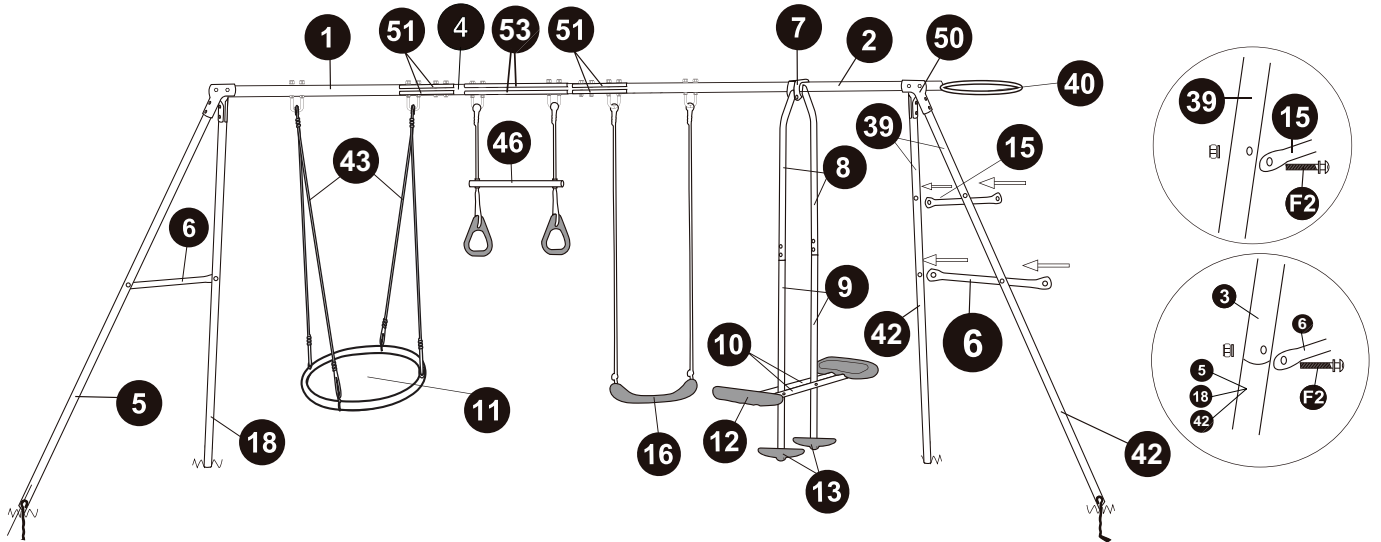

Correct Assembly

Incorrect Assembly

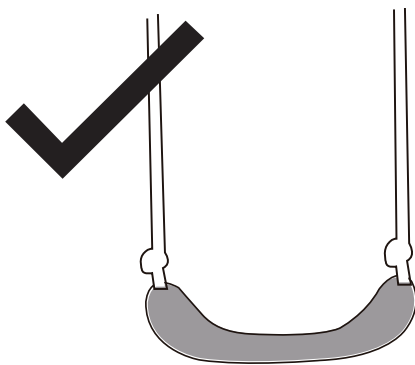

Position 1

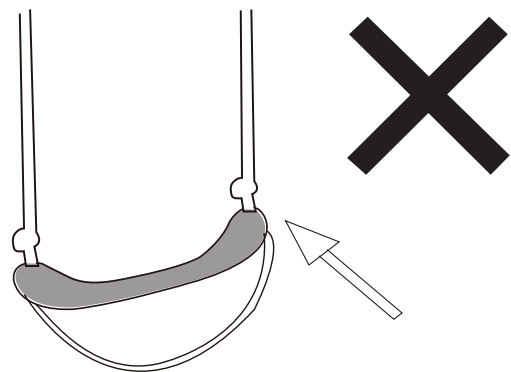

Position 2

Warning: The knots on the swings are integral to the safety of the swing. Please ensure that they are tight and that the swing is in POSITION 1 as shown in the diagram above. There should be no slack in the rope allowing a loop to form below the swing.

Assembly Instructions (cont)

Nest Swing Assembly

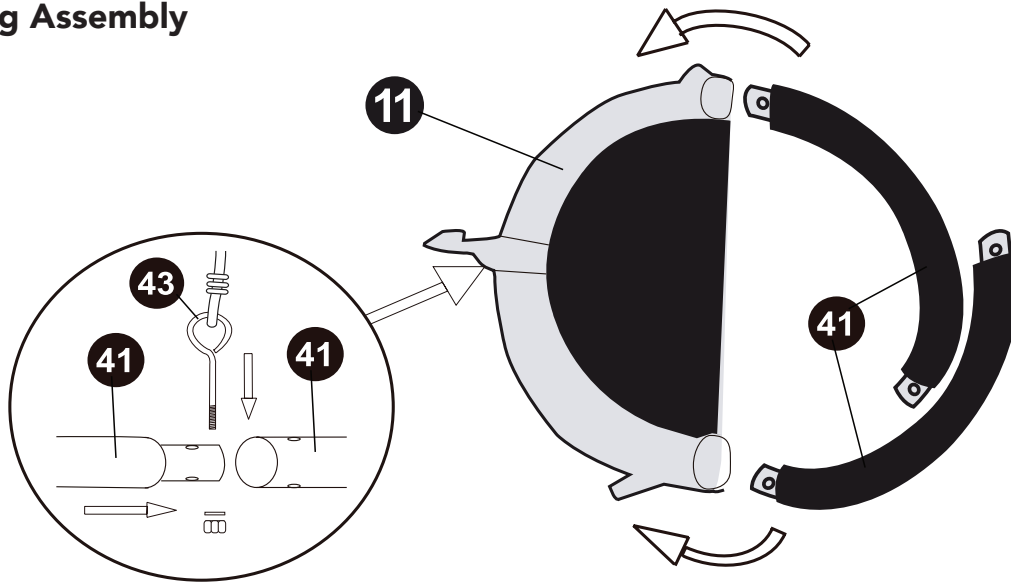

Insert the Metal Tube (11) into the fabric of the Nest Swing (41). Join the metal tubes together and then fasten them by using the bolt at the end of the Rope (43). (See above).

Repeat this for the other side, and then the Nest Swing becomes two semicircles (See below).

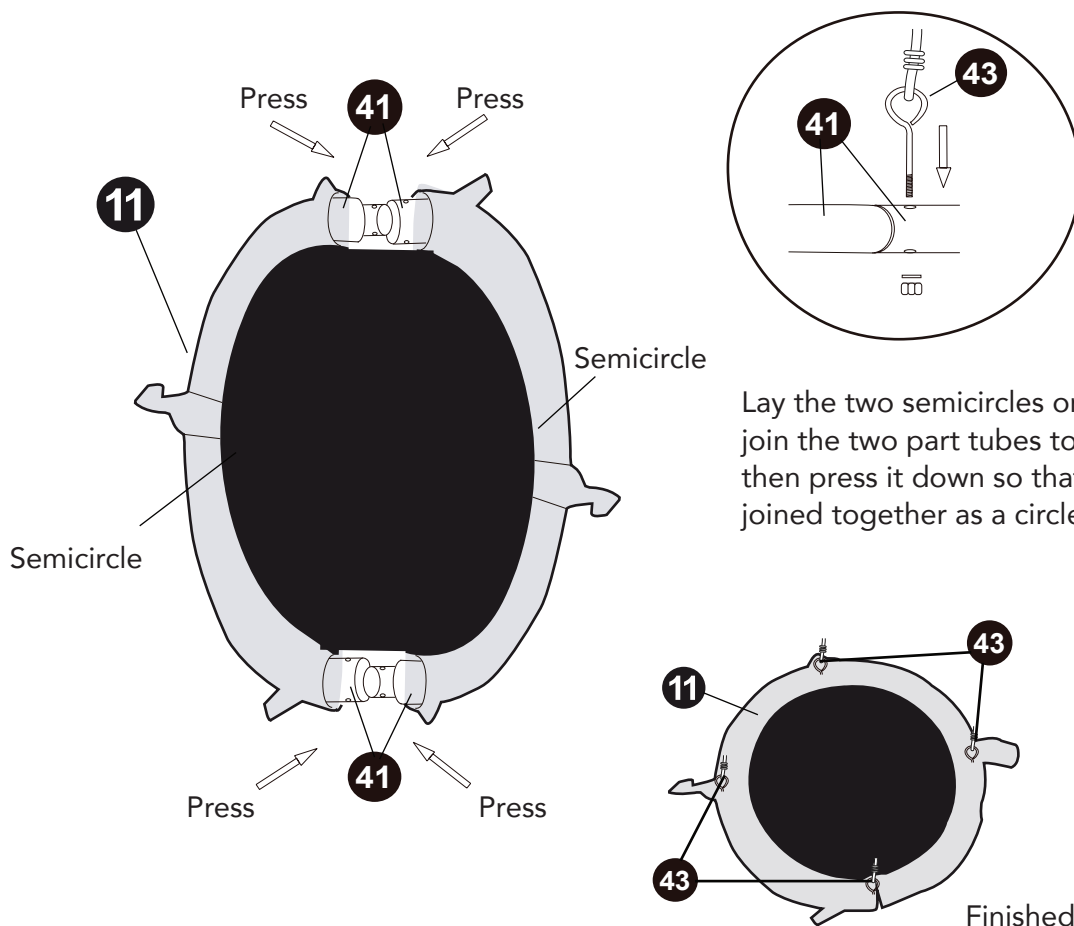

Lay the two semicircles on the ground, join the two part tubes together, and then press it down so that two parts are joined together as a circle.

Assembly Instructions (cont)

Step 2

Soccer Goal Net Assembly

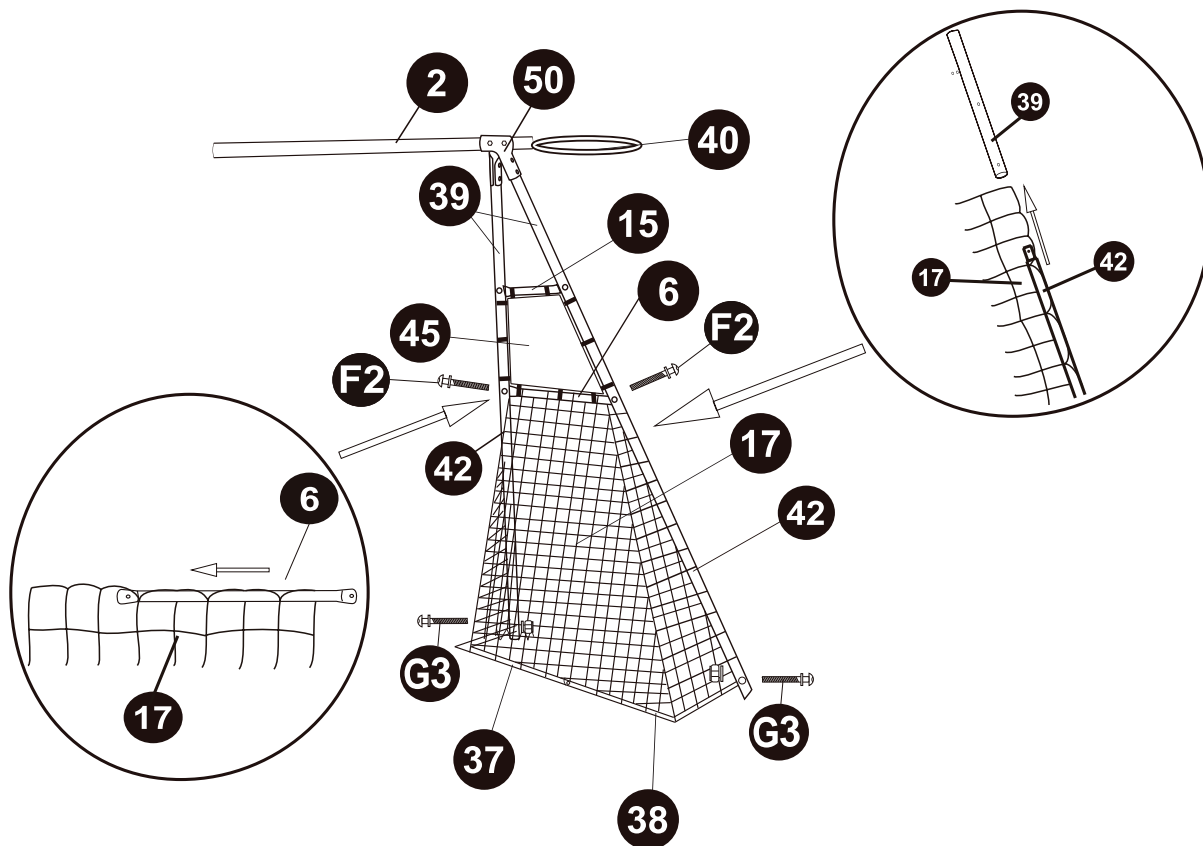

Thread the soccer goal net (17) through the metal tubes (42, 6, 37 and 38) and connect metal tube (42) and (6) by using the bolt (F2) and the bolt (G3) for the metal tube (42) and (37) with (42) and (38).

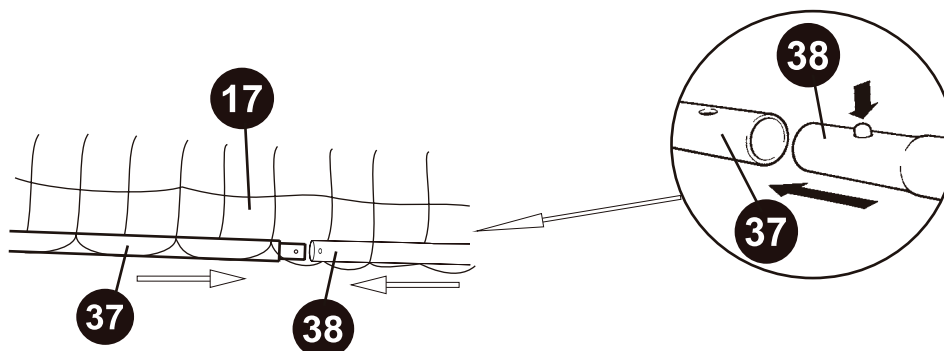

Connect the metal tube (37) & (38) as above.

Assembly Instructions (cont)

Step 3

Glider Assembly

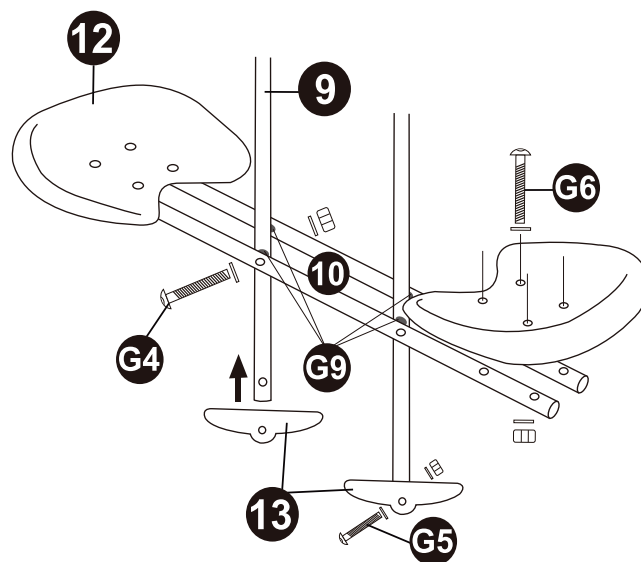
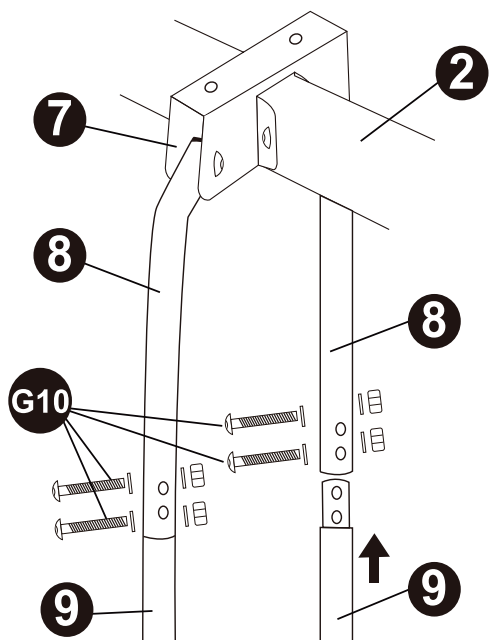
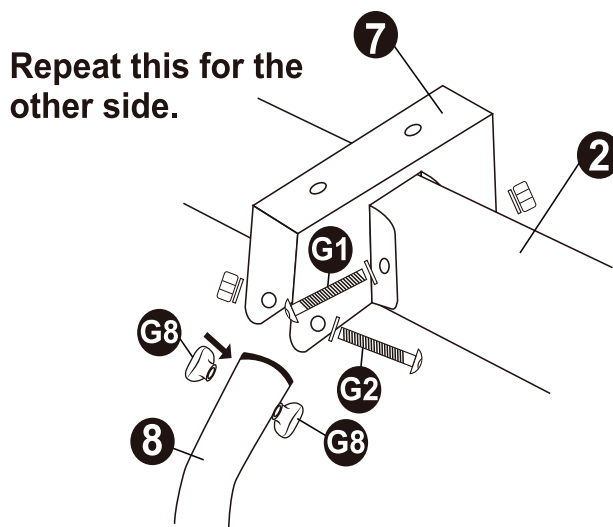
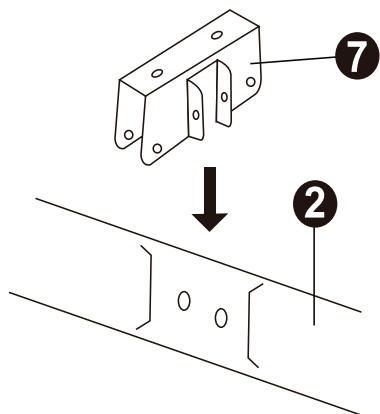

Assemble seats (12) and attach to seat tubes (10) before tightening bolts (G4).

Assembly Instructions (cont)

Step 4

Slide Assembly

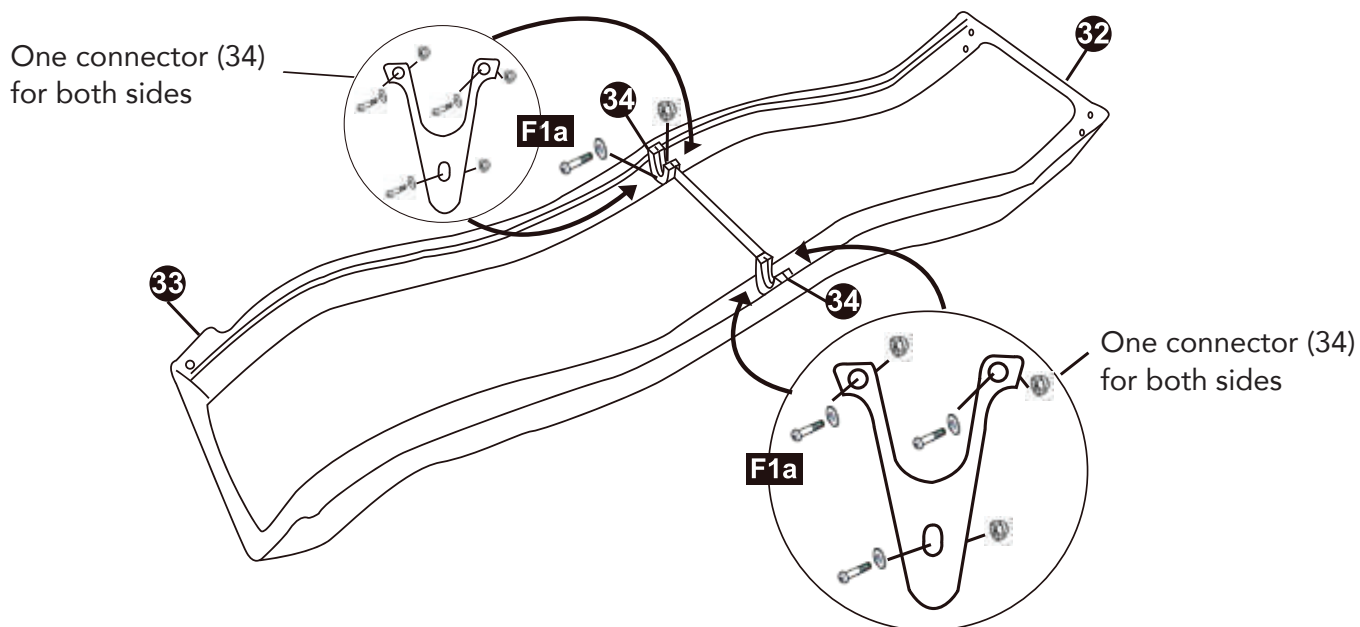

Bracket Assembly

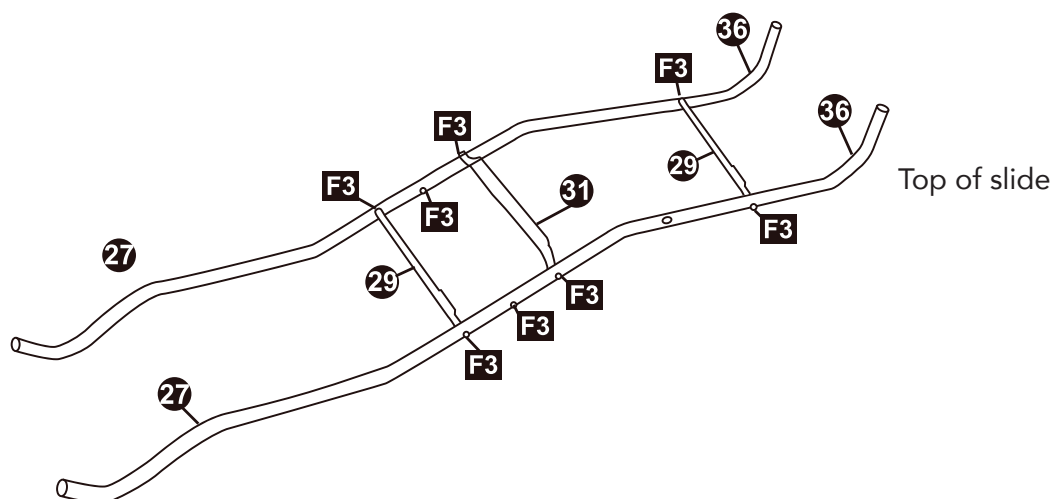

The M6 Bolt 35mm (F3) for support strap (29 and 31) only need to be finger tight.

Assembly Instructions (cont)

Assembly of the Bracket onto the Slide

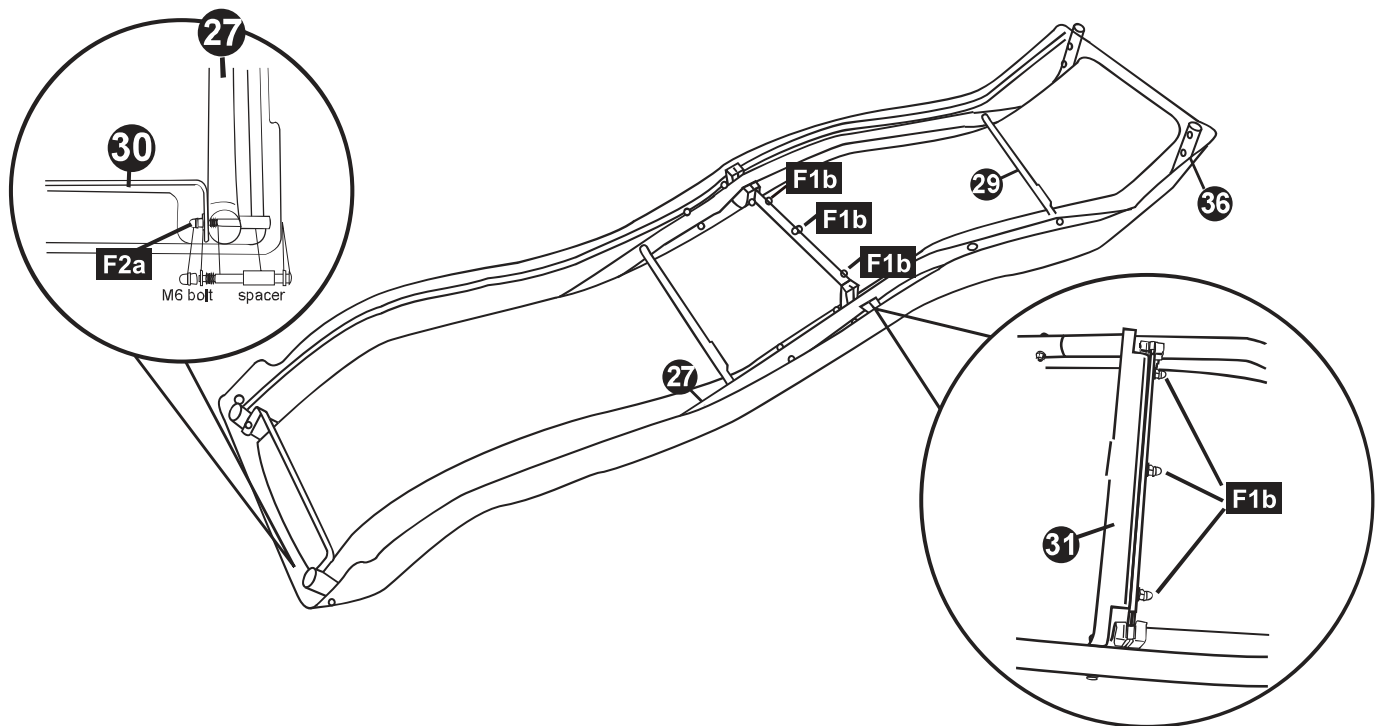

Assembly Instructions (cont)

Step 5

Slide Assembly continued

Note: Top Ladder Rung (19) is to be fitted behind Ladder Handle (26 and 28) and Plain Bottom Leg B (18).

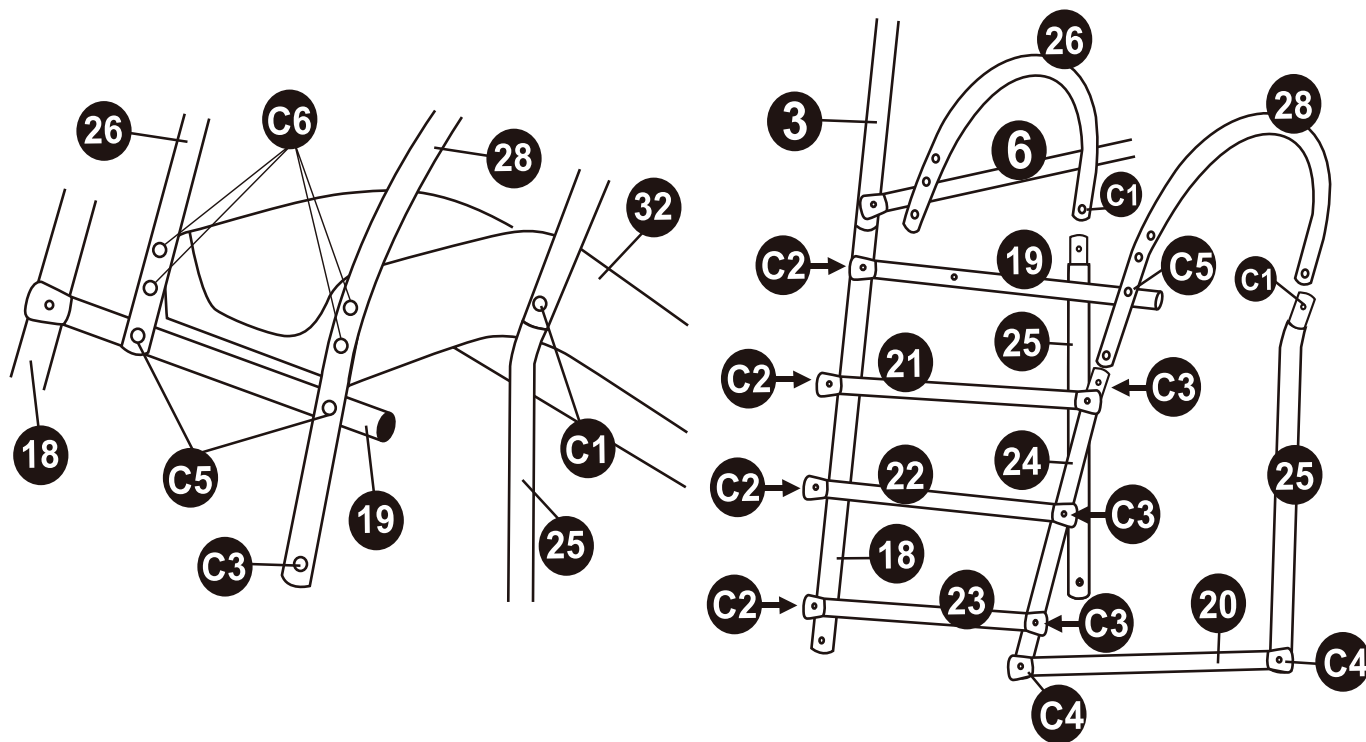

Assembly Instructions (cont)

Please do not overtighten nuts and bolts. Use hand tools only. Do not use power tools. This can weaken the connection points.

Please ensure that Top Ladder Rung (19) is fitted behind both Ladder Handles (26 and 28) and on the rear of the Bottom Leg (18).

Please see the below image for correct assembly.

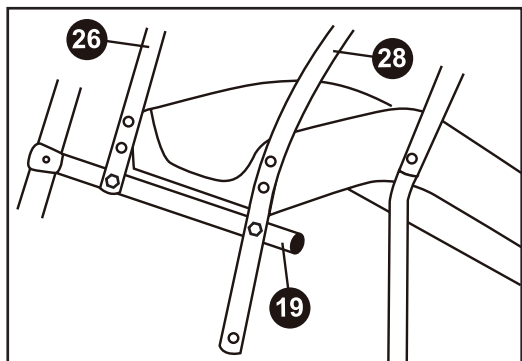

Correct Assembly

Please note that the Top Ladder Rung (19) is behind the Ladder Handles (26 and 28) supporting the slide.

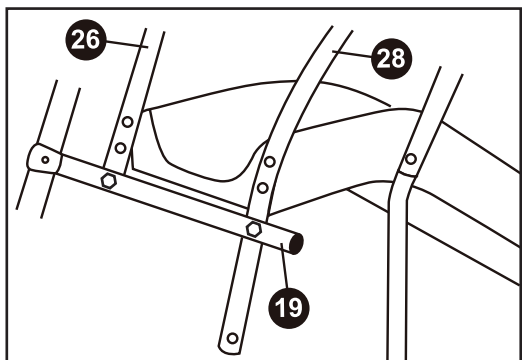

Incorrect Assembly

Please note that the Top Ladder Rung (19) is in front of the Ladder Handles (26 and 28) and not supporting the slide.

Please assemble Chute Side Stay Bar (20) last. Leave the bolts loose until the slide is assembled to the ladder frame, to make construction easier. Then tighten firmly.

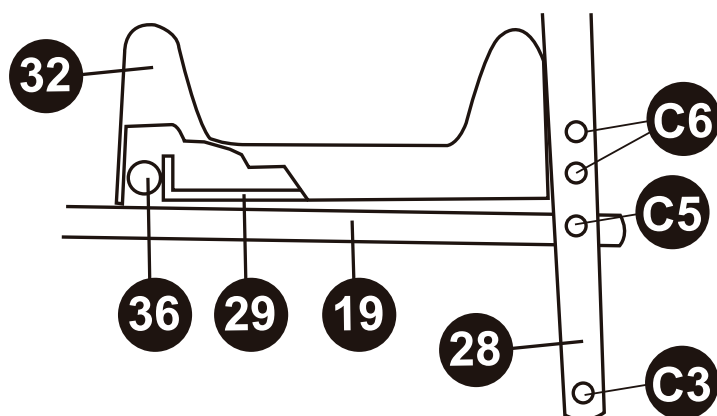

Assembly Instructions (cont)

Step 6

Anchoring the Swing Set to the ground

Important: For safety reasons this swing set MUST be anchored into the ground. To carry out this procedure, you must hammer the included pegs into the ground on the angle shown below. The peg must pull into hard earth and hold firmly. Attach the swing to the pegs at the connection points shown below. We highly recommend these anchor pegs be concreted, but this is optional. However if the ground is soft and the peg can easily be pulled out by hand once installed, concreting is essential. Contact our service centre for more information.

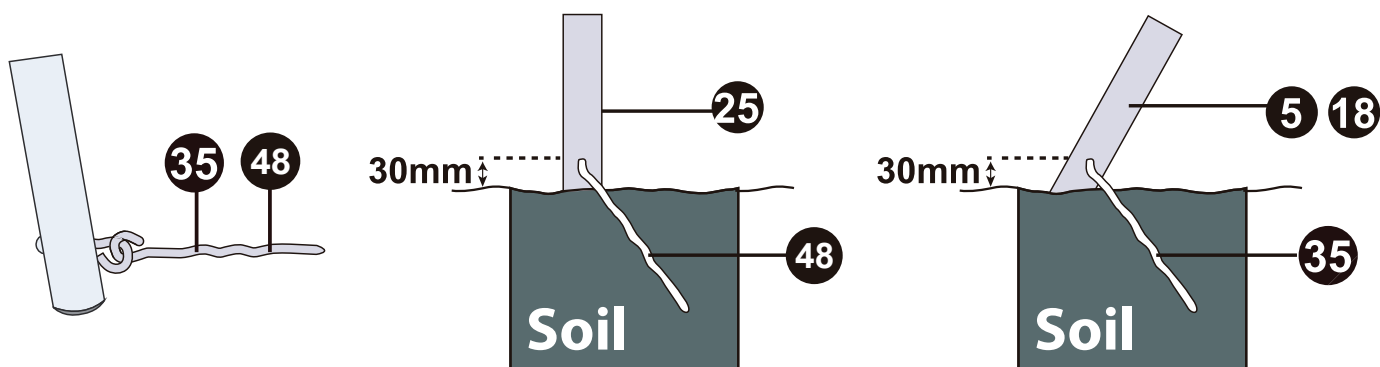

Once assembly is completed, carefully check equipment. In the unlikely event that you do find any problems, please contact us. DO NOT allow children to use this product until the problem has been corrected.

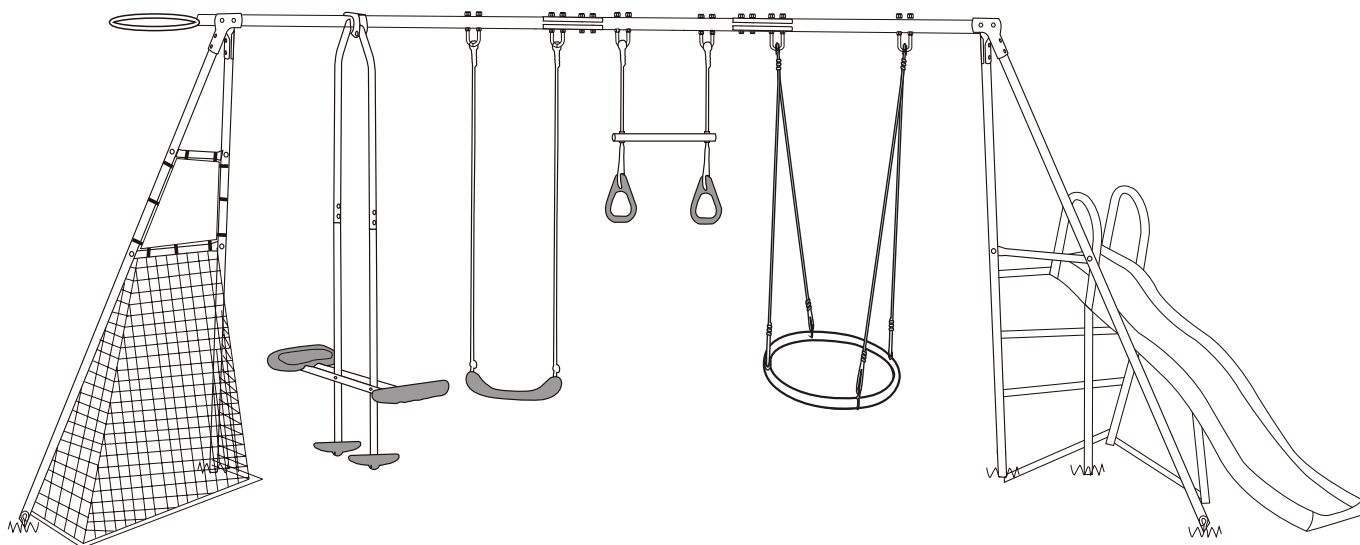

Warranty Information

Congratulations on your purchase!

This **Action 7 Station Swing Set** is warranted to be free from defects in material and workmanship under normal use and service conditions for a period of **12 months** from the date of purchase of this article. Evidence of unfair usage or incorrect adjustment by the owner will void this promise.

Our goods come with guarantees that cannot be excluded under the Australian Consumer Law. You are entitled to a replacement or refund for a major failure and for compensation for any other reasonably foreseeable loss or damage. You are also entitled to have the goods repaired or replaced if the goods fail to be of acceptable quality and the failure does not amount to a major failure.

The benefits conferred by this warranty are in addition to the consumer guarantees and other rights and remedies in respect of the product which the consumer has under the Australian Consumer law.

Conditions of Warranty

All warranty coverage extends only to the original retail purchaser from the date of purchase. Please keep your receipt, tax invoice or other proof of purchase.

This warranty does not extend to any damage to a product caused by abuse, improper or abnormal usage, or repairs not provided by us or our Service Centre. Nor does this warranty extend to products used for commercial or rental purposes. This warranty does not cover ordinary wear, tear and weathering, failure to follow directions, improper installation, improper maintenance or acts of God (such as damage caused by storms, lightning, heavy winds and by snow or ice).

Making A Warranty Claim

In order to make a claim under this warranty please direct your enquiries to our Service Centre. You can contact them on our **Freecall 1800 465 070** number or send mail to them at National Service Centre: 2/24 Anderson Road, Smeaton Grange, NSW 2567 – if mailing please include your contact details.

A service representative will then assist you in the appropriate action to be taken. For efficient processing of your enquiry please have proof of purchase, the date of purchase and the retailer name you purchased the item from, and the brand on the product. Photos of the product, and scans of receipts, may be requested to assist with your claim.

Warranty Information (cont)

The service centre representative will assess the claim. If:

- 1) **there is a minor fault**, they can offer either a replacement spare part, replacement unit, repair or other suitable remedy.
- 2) **there is a major fault**, they can offer a replacement, repair or suggest you return to the store you purchased it from for a full refund.

Please note: a request for compensation will need documentary evidence of the loss or damage suffered. It will also need to be evidenced that such a loss was a reasonably foreseeable result of a failure to comply with a consumer guarantee under the Australian Consumer Law.

- 3) **The product was damaged through abnormal use**, no refund or repair can be offered.

The sending of replacements, spare parts or the cost of repair carried out will be organized and covered by the Service Centre. If collection of the item is required this will be organized by the Service Centre and at our expense. Do not return any products without authorization as this will be at your expense.

Our sales and service centre has been set up to provide assembly assistance, replacement parts and accessories, and to efficiently handle all warranty related matters. Please note upon receiving your warranty claim our Service Centre will send, via post or email, a repair and refurbished goods or parts notice.

SERVICE CENTRE

Contact details and hours of operation.

Freecall 1800 465 070

9:00am – 4:30pm Monday to Friday (excluding Public Holidays)

9:00am – 3:00pm Saturday

This product is warranted and distributed by:

Action Sports of 48B Egerton St, Silverwater NSW, 2128

Phone: (02) 8799 3500

© 2017 Action Sports Equipment Pty Ltd.